



ALÜMİNYUM ÇİT VE KIŞ BAHÇESİ SİSTEMLERİ

ALUMINIUM FENCE & WINTER GARDEN SYSTEMS



www.arfenaluminum.com.tr



CE



ARFEN[®]

"Çözüm Üretir"

ALÜMİNYUM ÇİT SİSTEMLERİ

ARFEN Alüminyum Çit Sistemleri yüksek mukavemet gücü, estetik modern ve kolay uygulanabilirliği ile tüm eloksallı renkleri ve RAL boya renkleriyle yapılarınıza estetik bir görünüm sağlar.

High static strength, esthetic, modern and easy application provides you with an esthetic look to your structure with all anodised colors and RAL paint colors.

» Kolay Montaj

Easy to mounting

» Renk ve Model Seçekleri

All color and models options

» Özel Üretim Seçenekleri

Special manufacturing options

» Hazır Paket Sistem

Ready package systems

UYGULAMA AŞAMALARI

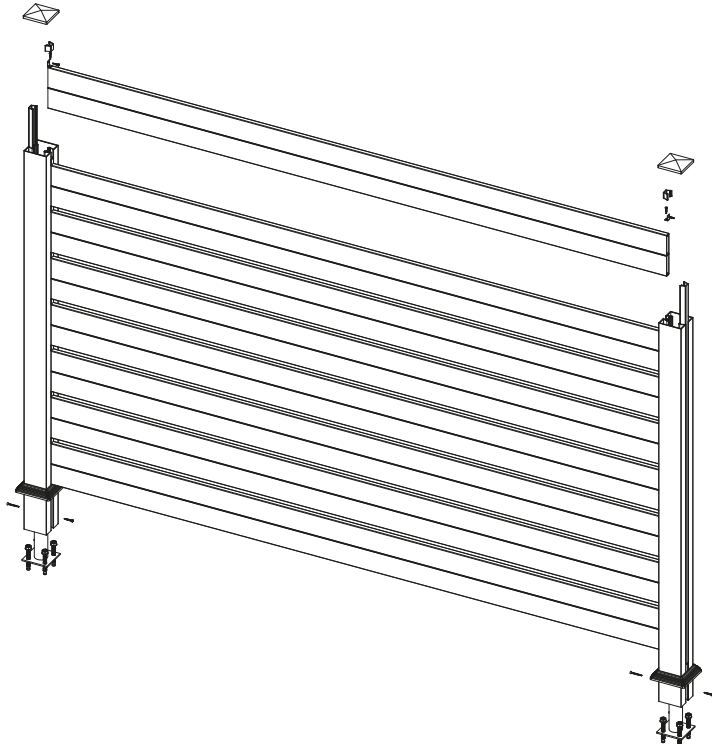

PROFİLLER PROFILES

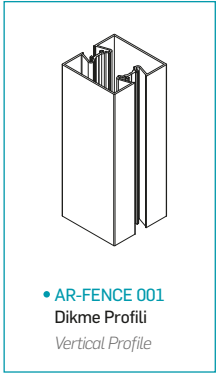

• AR-FENCE 001
Dikme Profili
Vertical Profile

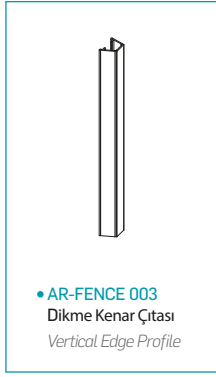

• AR-FENCE 003
Dikme Kenar Çıtası
Vertical Edge Profile

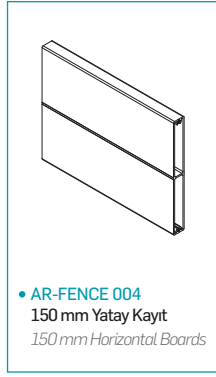

• AR-FENCE 004
150 mm Yatay Kayıt
150 mm Horizontal Boards

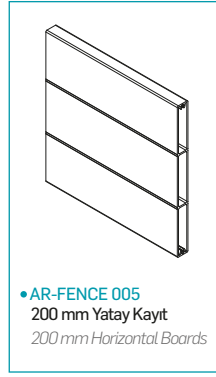

• AR-FENCE 005
200 mm Yatay Kayıt
200 mm Horizontal Boards

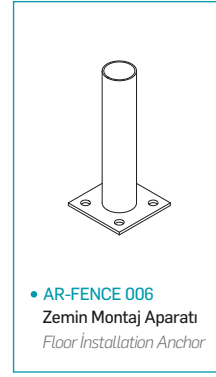

• AR-FENCE 006
Zemin Montaj Aparatı
Floor Installation Anchor

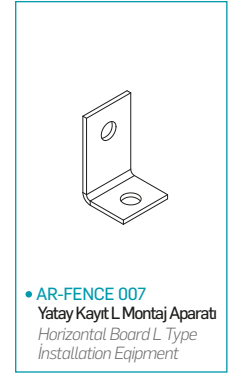

• AR-FENCE 007
Yatay Kayıt L Montaj Aparatı
Horizontal Board L Type
Installation Equipment

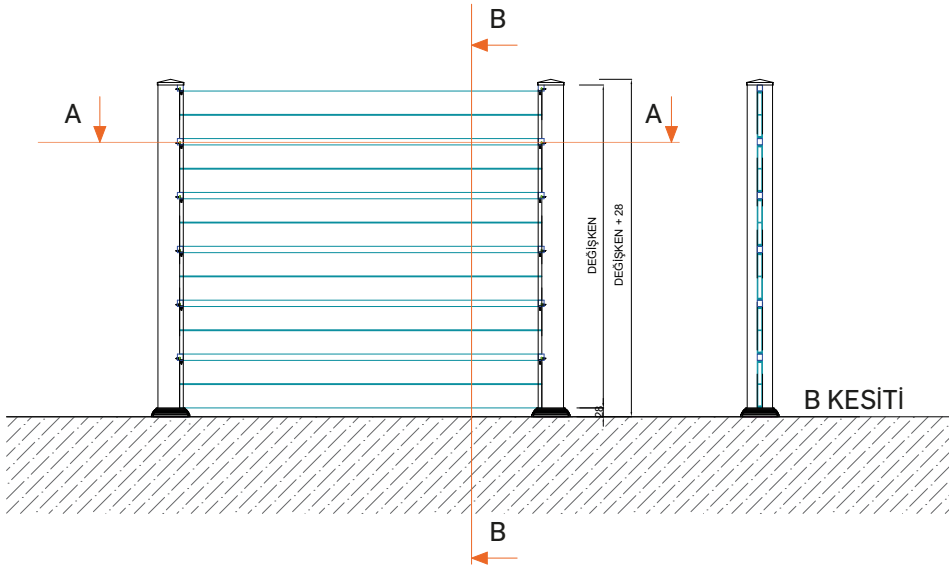

A KESİTİ

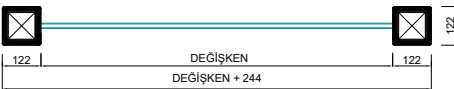

Aksesuarlar / Accessories

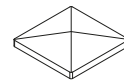

• AR-FENCE 008
Dikme Kapak Profili
Vertical Profile End Cap



• AR-FENCE 009
Dikme Flaşı
Vertical Profile Flange



 **ARFEN®**



ALÜMİNYUM KIŞ BAHÇESİ SİSTEMLERİ

ARFEN kış bahçesi için müstakil konutlar her ne kadar ideal olsa da boş arazilerinizde özel kullanım içinde kış bahçesi yaptırabilirsiniz. Kış bahçesi uygulamalarımız villa tipi müstakil yapılar ile birlikte yapılabildiği gibi ayrı olarak da uygulaması ve imalatı yapılabilmektedir. Konforlu ve kaliteli bir yaşam için yapılarınızda ARFEN kış bahçesi sistemleri ile her mevsim yaşanılabilir alanlar sunuyoruz.

» Kolay Montaj

Easy to mounting

» Renk ve Model Seçekleri

All color and models options

» Özel Üretim Seçenekleri

Special manufacturing options

» Dayanıklı Sistem

Ready package systems

UYGULAMA AŞAMALARI

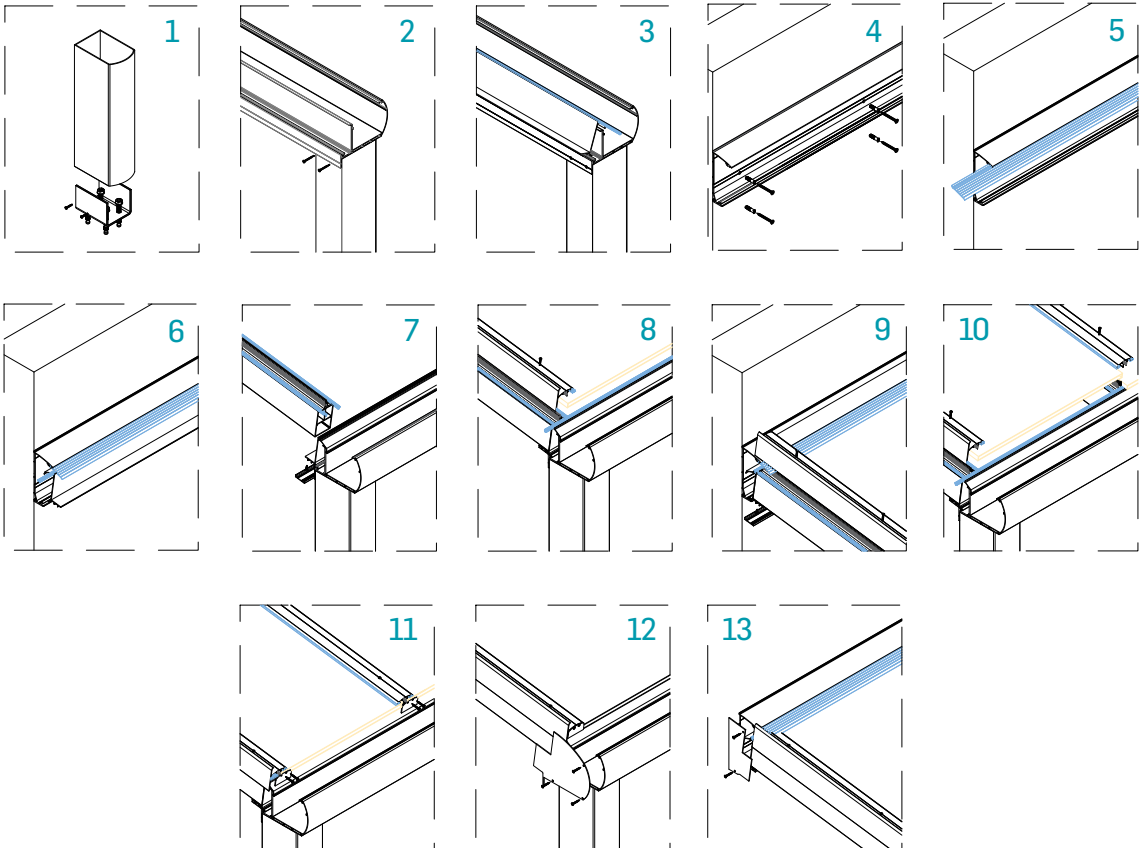

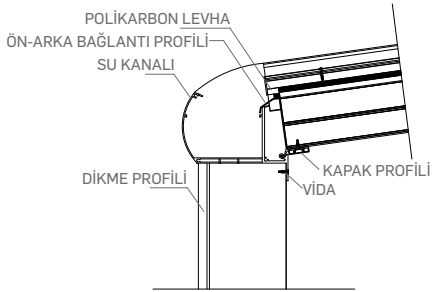

Dikme & Ara Bağlantı & Su Kanalı Detayı

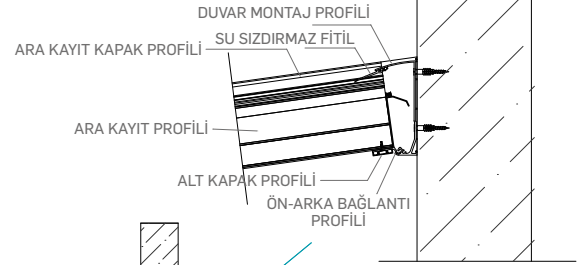

Duvar Bağlantı Detayı

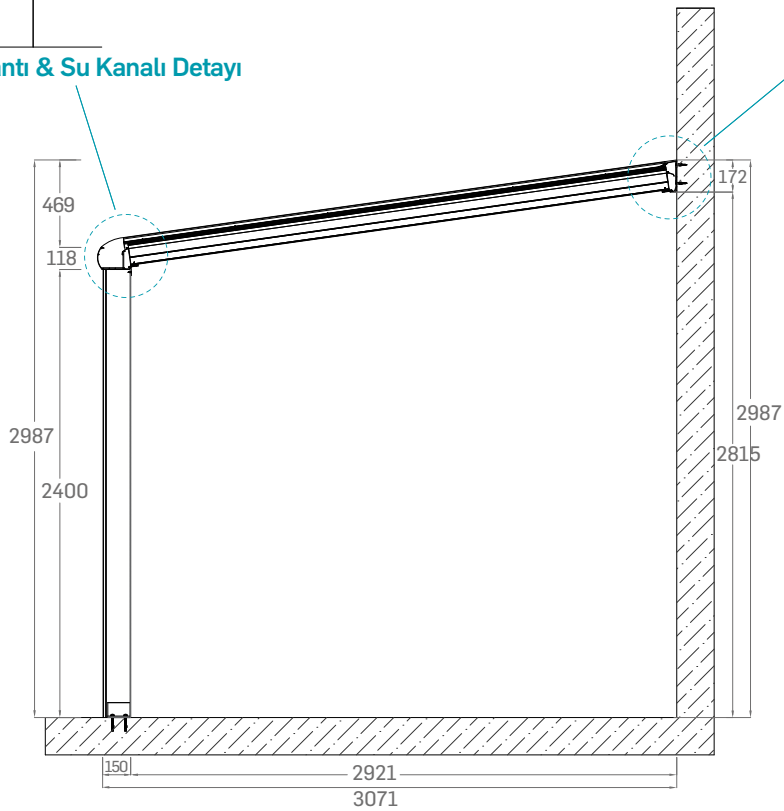

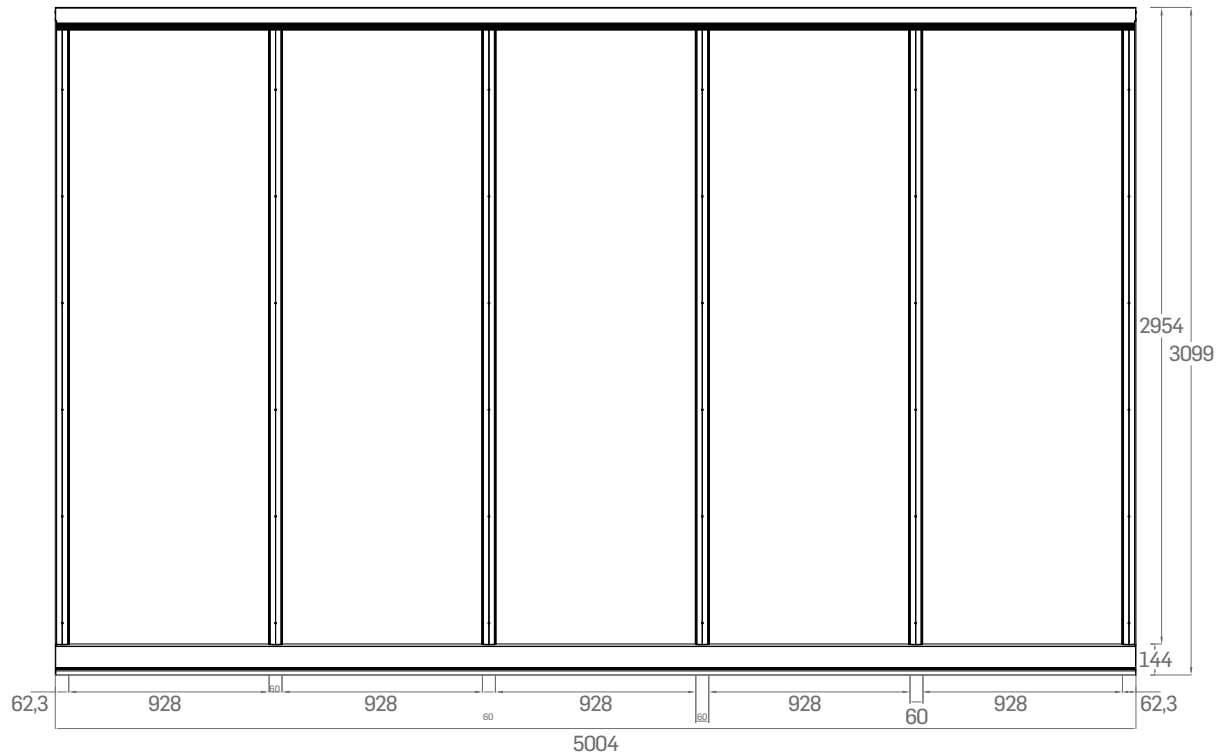
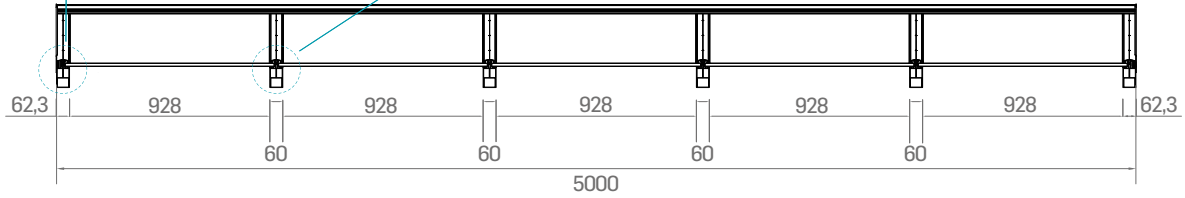
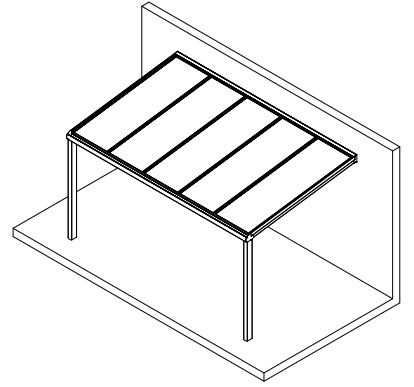
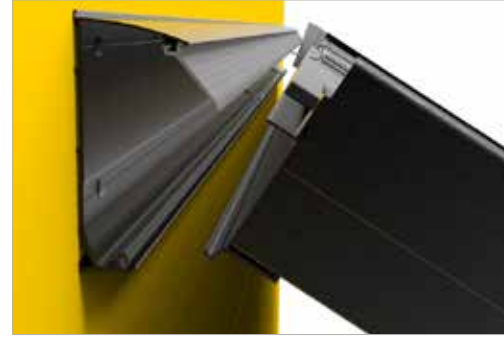
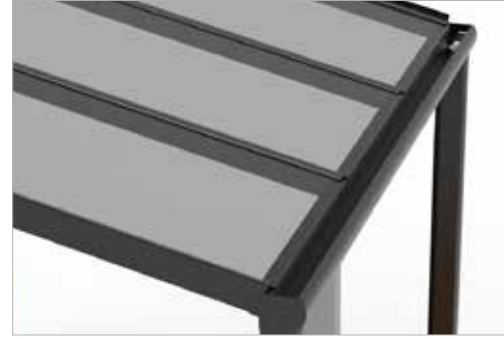

PROFİLLER

PROFILES

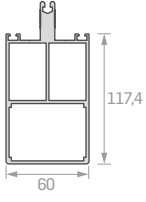

• 1653
Griyaj Profili
GRIYAJ PROFILE
Ağırlık / Weight: 2,724

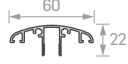

• 1654
Griyaj Kapak Profili
GRIYAJ COVER PROFILE
Ağırlık / Weight: 0,545

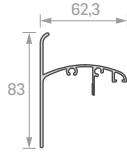

• 1660
Griyaj Kenar Kapak Profili
GRIYAJ EDGE COVER PROFILE
Ağırlık / Weight: 0,919

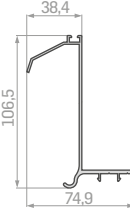

• 5707
Geçme Açı Profili
ANGLE PROFILE
Ağırlık / Weight: 1,073

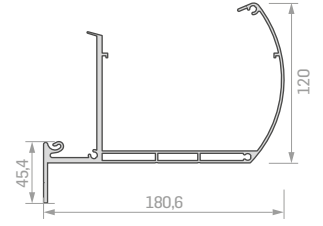

• 1656
Oluk Profili
BORDER PROFILE
Ağırlık / Weight: 4,046

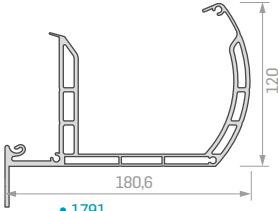

• 1791
Oluk Profili
BORDER PROFILE
Ağırlık / Weight: 5,742



• 1661
Oluk Destek Profili
BORDER SUPPORT PROFILE
Ağırlık / Weight: 1,131

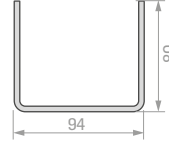

• 1659
Kolon İçi U Profil
COLUMN INSIDE U PROFILE
Ağırlık / Weight: 2,615

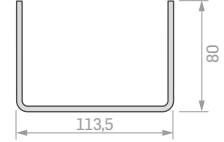

• 1745
Kare Kolon İçi U Profil
SQUARE COLUMN INSIDE U PROFILE
Ağırlık / Weight: 2,821

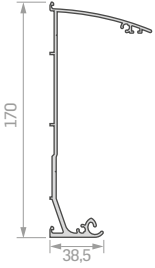

• 1658
Duvar Sabitleme Profili
WALL FIXING PROFILE
Ağırlık / Weight: 2,086

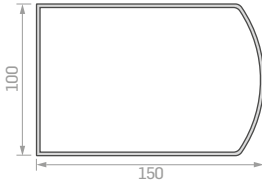

• 1657
Kapaksız Kolon Profili
COLUMN PROFILE WITHOUT COVER
Ağırlık / Weight: 2,905

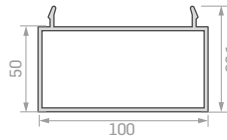

• 1790
Kapaklı Kolon Alt Profili
COLUMN BELOW PROFILE WITH COVER
Ağırlık / Weight: 1,976

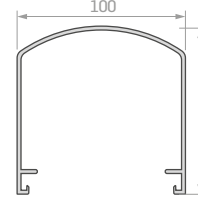

• 1789
Kapaklı Kolon Üst Profili
COLUMN UPPER PROFILE WITH COVER
Ağırlık / Weight: 1,875

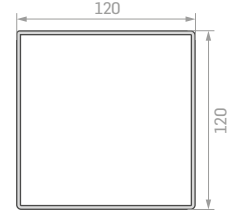

• 1695
Kare Kolon Profili
SQUARE COLUMN PROFILE
Ağırlık / Weight: 3,165

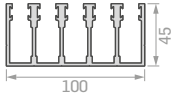

• 1592
4 Kanallı Kalın
Sürme Üst Kasa Profili
SLIDING THICK FRAME UPPER
PROFILE WITH 4 CHANNELS
Ağırlık / Weight: 2,948

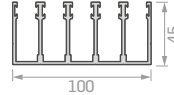

• 1604
4 Kanallı İnce
Sürme Üst Kasa Profili
SLIDING THIN FRAME UPPER
PROFILE WITH 4 CHANNELS
Ağırlık / Weight: 2,504

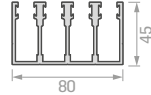

• 1593
3 Kanallı Kalın
Sürme Üst Kasa Profili
SLIDING THICK FRAME UPPER
PROFILE WITH 3 CHANNELS
Ağırlık / Weight: 2,488

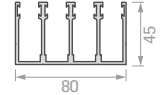

• 1605
3 Kanallı İnce
Sürme Üst Kasa Profili
SLIDING THIN FRAME UPPER
PROFILE WITH 3 CHANNELS
Ağırlık / Weight: 2,038

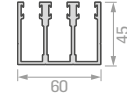

• 1594
2 Kanallı Kalın
Sürme Üst Kasa Profili
SLIDING THICK FRAME UPPER
PROFILE WITH 2 CHANNELS
Ağırlık / Weight: 1,827

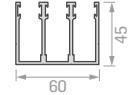

• 1606
2 Kanallı İnce
Sürme Üst Kasa Profili
SLIDING THIN FRAME UPPER
PROFILE WITH 2 CHANNELS
Ağırlık / Weight: 1,572

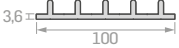

• 1584
5 Kanallı Eşiksiz Alt Sürme Profili
SLIDING FRAME LOWER
PROFILE NON-THRESHOLD
WITH 5 CHANNELS
Ağırlık / Weight: 1,466



• 1595
4 Kanallı Eşiksiz Alt Sürme Profili
SLIDING FRAME LOWER
PROFILE NON-THRESHOLD
WITH 4 CHANNELS
Ağırlık / Weight: 1,173

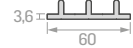

• 1596
3 Kanallı Eşiksiz Alt Sürme Profili
SLIDING FRAME LOWER
PROFILE NON-THRESHOLD
WITH 3 CHANNELS
Ağırlık / Weight: 0,851

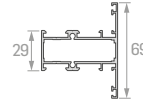

• 1598
Orta Kayıt Profili
MIDDLE RECORD PROFILE
Ağırlık / Weight: 1,060

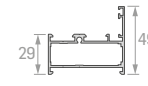

• 1599
L Kasa Profili
L SHAPE FRAME PROFILE
Ağırlık / Weight: 0,864



• 1597
Tip 1 Kanat Profili
TYPE 1 WING PROFILE
Ağırlık / Weight: 0,829



• 1603
Tip 2 Kanat Profili
TYPE 2 WING PROFILE
Ağırlık / Weight: 0,927



• 1600
4+4 mm Cam Çıtası
4+4 mm GLAZING
BEAD PROFILE
Ağırlık / Weight: 0,320



• 1601
5+5 mm Cam Çıtası
5+5 mm GLAZING
BEAD PROFILE
Ağırlık / Weight: 0,290



• 1602
Geniş Bitim U Profili
WIDE END U PROFILE
Ağırlık / Weight: 0,385



• 1744
Dar Bitim U Profili
NARROW END U PROFILE
Ağırlık / Weight: 0,374

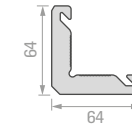

• 1632
Köşe Çavuş Profili
CORNER END PROFILE
Ağırlık / Weight: 3,900



• 1643
5+5 mm Cam Çıtası
5+5 mm GLAZING
BEAD PROFILE
Ağırlık / Weight: 0,317

AKSESUAR VE FİTİLLER



• 205.8058
Dış Cam Fitolü



• WDA-901
3 mm Kama Fitolü



• WDA-902
4 mm Kama Fitolü



• WDA-902
4 mm Kama Fitolü



• 8058
4 mm Kama Fitolü



• WDA-903
5 mm Kama Fitolü



• WDA-904
6 mm Kama Fitolü



• WDA-904
6 mm Kama Fitolü